

BRIVO ACS6000 INSTALLATION MANUAL

10/29/2018



LEGAL DISCLAIMERS

Federal Communications Commission (FCC) Compliancy

You are cautioned that changes or modifications not expressly approved by the part responsible for compliance could void the user's authority to operate the equipment.

This equipment has been tested and found to comply with the limits for a Class B digital device, pursuant to Part 15 of the FCC Rules. These limits are designed to provide reasonable protection against harmful interference in a residential installation or when the equipment is operated in a commercial environment. This equipment generates, uses, and can radiate radio frequency energy and, if not installed and used in accordance with the instruction manual, may cause harmful interference to radio communications. However, there is no guarantee that interference will not occur in a particular installation. If this equipment does cause harmful interference to radio or television reception, which can be determined by turning the equipment off and on, the user is encouraged to try to correct the interference by one or more of the following measures:

- Re-orient or relocate the receiving antenna.
- Increase the distance between the equipment and receiver.
- Connect the equipment into an outlet on a circuit *other* than the one to which the receiver is connected.
- Consult the dealer or an experienced radio/TV technician for help.

This device complies with Part 15 of the FCC Rules. Operation is subject to the following two conditions:

1. This device may not cause harmful interference and
2. This device must accept any interference received, including interference that may cause undesired operation of the device.

FCC RF Radiation Exposure Statement

1. This transmitter must not be co-located or operate in conjunction with any other antenna or transmitter.
2. This equipment complies with the FCC RF radiation exposure limits set forth for an uncontrolled environment. This equipment should be installed and operated with a minimum distance of 20 centimeters between the radiator and your body.

Underwriter Laboratories (UL) Compliance

The ACS6000 complies with the UL 294 Standard for access control units with the following restrictions:

- The Ethernet port is for supplemental use only. The unit will continue to operate standalone if the network connection is interrupted.
- The monitoring software is not UL evaluated.

Canada-Underwriters Laboratories (C-UL) Compliancy (CSA C22.2 No. 205)

For C-UL Listed applications, the unit shall be installed in accordance with Part 1 of the Canadian Electrical Code.

UL294 Performance Levels

Model Number	Access Control Line Security Level	Destructive Attack Level	Endurance Level	Stand-by Power Level	Conditions
Brivo ACS6000 and ACS6008	Level I	Level I	Level IV	Level I	N/A

Parts and Service

The ACS6000 control panel contains no user serviceable parts. The lithium battery is not serviceable and is to be replaced by qualified service technicians only.

Documentation Disclaimer and Restrictions

Information in this document is subject to change without notice and does not represent a commitment on the part of Brivo Systems LLC. For the most up-to-date information, visit www.brivo.com.

This document and the data herein shall not be duplicated, used or disclosed to others for procurement or manufacturing, except as authorized with the written permission of Brivo Systems LLC. The information contained within this document or within the product itself is considered the exclusive property of Brivo Systems LLC. All information in this document or within the hardware and software product themselves is protected by the copyright and/or other intellectual property laws of the United States.

Product Support

All support for this product is provided by the third-party dealer. Please contact the dealer who installed the product with questions and support requests.

© 2018 Brivo Systems LLC. All rights reserved.

Brivo® is a trademark of Brivo Systems LLC. Brivo Systems LLC., 7700 Old Georgetown Road, Suite 300, Bethesda, MD 20814

Table of Contents

INTRODUCTION	5
PRE-INSTALLATION PROCEDURES	7
GENERAL ASSEMBLY PROCEDURES	13
INSTALLATION PROCEDURES.....	22
POWERING AND TESTING PROCEDURES	37
CONFIGURATION PROCEDURES	39

INTRODUCTION

Document Objectives

This Installation Manual provides step-by-step instructions for installing the Brivo ACS6000 Control Panel. Its primary audience is trained access control installation technicians (Installers) who are responsible for installing the ACS6000 Control Panel at client sites.

This version of the manual is also intended for IT personnel, who should use it in conjunction with the Brivo Panel Networking Admin Interface Guide. It may be used by dealers and their sales professionals to help them conduct pre-sales, and to provide client support during the installation process. Finally, it may be used for in-house training purposes and ongoing support.

Document Layout

This manual is organized into a series of procedural checklists, detailing steps you must follow to ensure a safe and effective installation. The main sections of the manual are:

- Pre-Installation Procedures
- General Assembly Procedures
- Installation Procedures
- Powering and Testing Procedures
- Configuration Procedures

Terminology

Following is a list of terms that are used throughout this document. While some of these terms may have other meanings, the definitions provided below are the ones intended in this *Installation Manual*.

- *Control chassis*. The main chassis for a control panel. The control chassis contains the MAIN BOARD, POWER SUPPLY BOARD (PSB) and may also contain one expansion board, either a DOOR BOARD or an INPUT OUTPUT BOARD (if using a standard chassis) or three expansion boards in any combination of DOOR BOARDS or INPUT OUTPUT BOARDS (if using a large chassis).
- *Expansion chassis*. Additional chassis, containing POWER SUPPLY BOARD and one or two expansion boards, either DOOR BOARDS and/or INPUT OUTPUT BOARDS.
- *Large expansion chassis*. Additional chassis, containing POWER SUPPLY BOARD and up to four expansion boards, either DOOR BOARDS and/or INPUT OUTPUT BOARDS.
- *Control panel*. The complete system of control chassis and expansion chassis for an account. A control panel will have the MAIN BOARD (contained in the control chassis) and a number of additional expansion chassis (standard or large) to hold a maximum of 14 additional DOOR BOARDS and/or INPUT OUTPUT BOARDS (for a total maximum of 15 boards).
- *Access control system (ACS)*. The complete interaction between a control panel, the Brivo product (Onair or Onsite Server) and in the case of Brivo Onair, the Brivo Onair cloud server.
- *Brivo Onair*[®]. Brivo's cloud based software application which enables the end user to manage his or her Brivo Onair account.
- *Brivo Onair Cloud Server*. The off-site servers, hosted by Brivo, that are used to store an account's database. Configuration and maintenance of the control panel is managed through Brivo Onair.
- *Brivo Onsite Server*. Brivo's appliance-based application which enables the end user to manage his or her Brivo Onsite Server account.

Wiring Recommendations

Signal	Belden # or Equivalent	AWG	Twisted Pair	Conductor	Shielded?	Max Length
RS-485 Comm, two wire	9841	24	Yes		Yes	4000 ft
Power (22 gauge)	5504FE	22	Yes		Yes	600 ft
Power (18 gauge)	6300FE	18	Yes		Yes	1500 ft
RJ45-Ethernet	N/A	Cat5	Yes		Yes	1500 ft
CAN Bus	N/A	Cat 5	Yes		Yes	1500 ft
Fire Alarm Relay	6300FE	18	Yes		Yes	1500 ft
Request-to-Exit	5520FE/6300FE	22/18	Yes		Yes	1500 ft
Door Contact	5500FE	22	Yes		Yes	1500 ft
Transformer Block	6300FE	18	Yes		Yes	100 ft
Molex Connector	N/A	22	Yes		No	1 ft
Earth ground	N/A	6		Yes	Yes	20 to 40 ft
Reader Option 1 (22 AWG)	5504FE	22		Yes	Yes	250 ft
Reader Option 2 (20 AWG)	5400FE	20		Yes	Yes	300 ft
Reader Option 3 (18 AWG)	6300FE	18		Yes	Yes	500 ft

Additional Resources

The following additional resources are available for the installer as well as the client.

- [Panel Networking Admin Interface Guide](#)
- [Approved Wiegand and OSDP Reader List](#)
- [Installation Worksheet: Network](#)
- [Installation Worksheet: Door Board](#)
- [Installation Worksheet: Input Output Board](#)
- [Brivo Onair Quick Start Guide](#)
- [Brivo Cellular Network Router Configuration Guide](#)
- [Brivo Onsite Server Quick Start Guide](#)
- Technical Support: 1-866-BRIVO-4-U
- www.brivo.com

PRE-INSTALLATION PROCEDURES

Before you begin installing the Brivo control panel, perform the following tasks to ensure a safe, speedy, and successful installation.

Understand the function of the Brivo ACS6000 control panel.

The ACS6000-E and ACS6000-A are four (4) reader control panels with multiple access points (up to four readers per chassis). This control panel is considered a standalone system. The main board has two (2) readers on-board, and one additional expansion board can be integrated with the main board which will form the four (4) reader panel. Additional expansion panels (ACS6000-EXP) can connect to the main control panel with two expansion boards in each. Each expansion board can be a door board (two (2) readers on board) or an input-output board.

The Brivo ACS6000-E uses an on-board Ethernet interface to communicate via any TCP/IP networking technology that can be connected through a hub, router or switch, including Wi-Fi and satellite communications. It is an IP-enabled Access Control System that interacts with the Brivo Onair cloud server via the Internet application Brivo Onair.

The Brivo ACS6000-A is identical to the ACS6000-E except that the ACS6000-A communicates to a Brivo Onsite Server instead of the Brivo Onair cloud server.

The ACS6008-E and ACS6008-A are identical to their respective ACS6000 models except for a larger enclosure which allows for two additional expansion boards (door board or input-output boards). Also, the ACS6008 series are connected to two (2) 12V, 7Ah batteries for standby power (Batteries should be connected in parallel).

Understand Brivo ACS6000 control panel product compatibility.

The ACS6000 control panel is compatible with a large number of standard reader models including the following (UL tested for compatibility) reader models: HID600, Identiv 8110, HID RPK40, Allegion MTK15, AWID KP-6840, and OSDP reader 921PTPTEK00385. Brivo products are designed to accommodate the latest updates in Wiegand and OSDP using RS-485 reader formats. The ACS6000 control board is compatible with Wiegand devices that transmit up to 255-bit data and OSDP readers using RS-485.

A current list of compatible readers and keypads is maintained on Brivo's website at <http://www.brivo.com>. If you have a specific model of reader or keypad that is not listed on the Brivo website, please contact Technical Support at 1-866-BRIVO-4-U to determine compatibility.

Verify that the client site is ready to support the installation.

1. Check with the IT department to ensure that the ACS6000 control panel to be installed is compatible with the company's local area network (LAN).
 - a) The ACS6000 control panel is equipped with a standard RJ-45 socket that accepts a CAT5 or CAT6 cable with an RJ-45 plug on any 10/100 Ethernet network. Physically connecting the panel is the same as plugging any computer or other device into the LAN.
 - b) Refer to the [Panel Networking Admin Interface Guide](#) for instructions on connecting to the LAN. The [Panel Networking Admin Interface Guide](#) also contains a complete list of requirements regarding TCP/IP configuration parameters and information about security considerations.
2. Download the appropriate [Quick Start Guide](#) from the Brivo website and provide it to the Master Administrator. This document provides instructions for registering and configuring the control panel in the appropriate application.

3. For Brivo Onair accounts, make sure the account has been created and the control panel is registered through Brivo Onair. If the control panel has not been registered by the dealer, the installer may either contact Brivo Technical Support for assistance or simply register the panel directly.
4. Verify that the Master Administrator and any other employee who will be accessing the system have Internet access on a computer equipped with a supported Web browser.

Verify shipping contents.

1. Locate and check the contents of the Control Panel kit.

The ACS6000 control panel kit (B-ACS6000-MB) should contain the following parts:

- a) 1 metal chassis. Packed inside the chassis are:
 - An identify label to be adhered to the inside of the door.
 - 1 cardboard box containing the MAIN BOARD and main board accessories.
 - 1 MAIN BOARD
 - 1 anti-static bubble wrap bag
 - 1 MAIN BOARD Accessory Kit
 - 1 zipper bag
 - 2 metal oxide varistors
 - 16 2k ¼W 5% resistors
 - 5 ACS6000 style standoffs
 - 5 ACS5000 style standoffs
 - 1 dipole antenna – 2dB (Wi-Fi antenna)
 - 1 IPEX cable (Wi-Fi cable)
 - 1 earth ground screw
 - 1 4P power wire harness
 - 1 identity label
 - 1 cardboard box containing a power supply board (PSB) and PSB accessories.
 - 1 power supply board
 - 1 anti-static bubble wrap bag
 - 1 power supply board accessories kit
 - 1 zipper bag
 - 4 screws
 - 1 identity label
- b) 1 cardboard box containing accessories, including:
 - Pre-assembled CAN Bus cable (2 board connection cable for ACS6000, 4 board connection cable for ACS6008)
 - 1 AC transformer

- 1 7Ah lead-acid battery (x2 for ACS6008)
- c) 1 lock and key set
 - d) 1 documentation set, including:
 - Installation Manual (this document)
2. If additional DOOR BOARDS have been ordered with the control panel, locate and check the contents of each 2-Door Board (B-ACS6000-DB) Kit. There may be up to 15 of these kits, and each should contain the following parts:
- a) 1 DOOR BOARD
 - b) 1 anti-static bubble wrap bag
 - c) 1 DOOR BOARD Accessory Kit
 - 1 zipper bag
 - 2 metal oxide varistors
 - 16 2k ¼W resistors
 - 5 standoffs for the DOOR BOARD
 - 1 4P Power wire harness
 - d) 1 identity label
3. If additional INPUT OUTPUT BOARDS have been ordered with the control panel, locate and check the contents of each INPUT OUTPUT BOARD (B-ACS6000-IO) Kit. There may be up to 15 of these kits, and each should contain the following parts.
- a) 1 INPUT OUTPUT BOARD
 - b) 1 anti-static bubble wrap bag
 - c) 1 INPUT OUTPUT BOARD Accessory Kit
 - 1 zipper bag
 - 2 metal oxide varistors
 - 16 2k ¼W resistors
 - 5 standoffs for the INPUT OUTPUT BOARD
 - 1 4P power wire harness
 - d) 1 identity label
4. If additional expansion chassis have been ordered with the control panel, locate and check the contents of each Expansion Chassis Kit (B-ACS6000-EXP) or Large Expansion Chassis Kit (B-ACS6008-EXP). Each standard expansion chassis can hold up to two boards, including any combination of door and/or Input Output boards. Each large expansion chassis can hold up to four boards, including any combination of door and/or Input Output boards. There may be enough Expansion Chassis kits or Large Expansion Chassis Kits to hold 1 MAIN BOARD, and any combination of 14 door and/or Input Output boards. Each should contain the following parts:
- a) 1 metal chassis
 - 1 lid
 - 1 box

- 1 hinge pair short
 - 1 hinge pair long
- b) 1 lock and key set
- c) An identify label to be adhered to the inside of the door
- d) Battery and PSU cardboard box
- 1 power supply board
 - 1 pair of battery wires
 - 1 AC transformer
 - 1 7Ah lead-acid battery (x2 for ACS6008)

Plan your installation.

1. Determine the size of your control panel.
 - a. In addition to the control chassis, which contains the MAIN BOARD, there may be up to seven expansion chassis.
 - b. The control chassis contains the MAIN BOARD, which also serves as a 2-door board, and may also contain either a DOOR BOARD or an INPUT OUTPUT BOARD.
 - c. Each standard expansion chassis (ACS6000) may contain up to two boards, in any combination of DOOR BOARDS and/or INPUT OUTPUT BOARDS.
 - Each DOOR BOARD has two terminal nodes, each of which contains a complete set of terminals for controlling a door. This means that each DOOR BOARD can be used to control two doors.
 - The same inputs and outputs that drive a door can also be used for other devices. In other words, DOOR BOARDS do not need to be used to control doors.

	<p>WARNING: Door Wiring</p> <p><i>If a node is to be used for a door, do not connect any other device to the following terminal blocks: REX & DOOR, DOOR LOCK RELAY, and READER.</i></p>
--	---

- An INPUT OUTPUT BOARD cannot be used to control a door; however, it can be used in any circumstance that uses contact closure to track change of status.
- d. Each large expansion chassis (ACS6008) may contain up to four boards, in any combination of DOOR BOARDS and/or INPUT OUTPUT BOARDS.
- Each DOOR BOARD has two terminal nodes, each of which contains a complete set of terminals for controlling a door. This means that each DOOR BOARD can be used to control two doors.
 - The same inputs and outputs that drive a door can also be used for other devices. In other words, DOOR BOARDS do not need to be used to control doors.

	<p>WARNING: Door Wiring</p> <p><i>If a node is to be used for a door, do not connect any other device to the following terminal blocks: REX & DOOR, DOOR LOCK RELAY, and READER.</i></p>
--	---

- An INPUT OUTPUT BOARD cannot be used to control a door; however, it can be used in any circumstance that uses contact closure to track change of status.
2. Using the packing slip as a guide, complete the appropriate Installation Worksheets included with your documentation set.

Decide where to install each chassis.



1. Do not place the control chassis more than 100 feet from the transformer. This is the maximum cable run allowed by the ACS power supply.
2. Calculate the distance between the control chassis and each expansion chassis using the chart in Table 1 below. The calculations are based on the following restrictions.
 - a) The control chassis, containing the MAIN BOARD, and the first expansion chassis can be up to 1500 feet apart.
 - b) Each time another expansion chassis is added, the maximum distance between the first and last chassis decreases by 50 feet. So, if there are three chassis in a system, the control chassis plus two expansion chassis, the two most distant chassis can be no more than 1450 apart.

Total # of chassis	Max allowed distance
2	1500
3	1450
4	1400
5	1350
6	1300
7	1250
8	1200

Maximum Distance Calculations

- c) Calculate the distance between each chassis and its associated keypad or reader. The ACS6000 does not specify a maximum distance between the chassis and a keypad or reader, *but the keypad/reader manufacturer does*. Follow manufacturer guidelines for each keypad and reader.
- d) Place each chassis within 500 feet of its associated electronic strike or latch.

Follow safety precautions.

	<p>WARNING: Fire Code</p> <p>NEVER CONNECT A KEYPAD/READER OR LOCK TO DOORS WITHOUT FIRST CONSULTING THE APPLICABLE FIRE CODE. <i>You must consult with, and get approval from, local fire officials before installing locks or devices on any doors that may be fire exits. Use of egress push buttons may not be legal. Single action exits may be required. Always obtain proper permits and approvals in writing before installing equipment</i></p>
	<p>WARNING: Fail Secure Mode</p> <p>DO NOT INSTALL THE SYSTEM IN THE FAIL SECURE MODE UNLESS PERMITTED BY THE LOCAL AUTHORITY HAVING JURISDICTION. <i>Doing so may cause interference with the operation of panic hardware.</i></p>
	<p>WARNING: Heat and Noise</p> <p>DO NOT INSTALL THE CONTROL PANEL IN AN AREA THAT COULD DROP BELOW 32 DEGREES FAHRENHEIT OR EXCEED 120 DEGREES FAHRENHEIT. <i>Doing so can cause damage to components within the control panel.</i></p> <p>DO NOT INSTALL THE CONTROL PANEL NEAR OR ON THE SAME CIRCUIT WITH DEVICES THAT PRODUCE LARGE AMOUNTS OF ELECTRICAL NOISE. <i>This includes grinders, electric motors and blowers, electrical switch-gear and other electrically noisy equipment. Electrical noise can interfere with panel operation. If it is not possible to install the panel away from such sources of noise, it is advisable to isolate it by using a high-quality UPS (Uninterruptible Power Supply) between the AC Mains and the transformer.</i></p>

GENERAL ASSEMBLY PROCEDURES

Assemble and mount chassis.

1. Stick the identity label to the inside of the metal chassis.
2. Install the supplied nylon stand-offs into each chassis by inserting them from the rear.



NOTE: *This step MUST be performed before the chassis is mounted to the wall. Once the chassis has been mounted, it is not possible to insert the stand-offs.*

- a) For the MAIN BOARD, there are 5 standoffs and 1 screw for the ground post, but there are more holes than that in the chassis.
- b) For DOOR BOARDS and INPUT OUTPUT BOARDS, there are five stand-offs for each board, but there are more holes than that in the chassis.
- c) Determine which holes you will use based on the size of the boards you are installing.
3. Mount the chassis.
 - a) Use four bolts to mount each chassis securely in place.
 - b) Make sure the chassis door can swing open freely to allow for access after the installation is complete.
 - c) In tight spaces, the removable hinge design of the ACS6000/ACS6008 enclosures allow an installer to completely remove the chassis door and replace it just as easily upon completion of the installation.
4. Remove any knock-outs that may be required to accommodate conduit or wiring.



WARNING: Knockouts

DO NOT ATTEMPT TO REMOVE THE KNOCKOUTS WITH A HAMMER. *Banging on the knockouts may result in shock to the circuit boards, which could cause permanent damage. Pry them out using a screwdriver.*

5. Assemble the chassis.
 - a) Install the power supply board in each chassis first. If you install the MAIN BOARD or a Door or INPUT OUTPUT BOARD first, you may find it difficult to position your screwdriver in a way that will allow you to install the power supply board later.
 - b) Install the MAIN BOARD in the control chassis.
 - Install each board by aligning it with the previously installed stand-offs and then gently pressing it into place. You will hear a slight click as the board settles into the locked position on the standoffs.
 - After that, screw on the ground post screw on the bottom left corner.
 - c) If there is a DOOR BOARD or an INPUT OUTPUT BOARD for the control chassis, install that now, using the procedures described for the MAIN BOARD.

- d) If there are expansion chassis, install the appropriate DOOR BOARDS and/or INPUT OUTPUT BOARDS in each chassis at this time, using the procedures described for the MAIN BOARD.
 - e) You will note that the control panel kit contained an adhesive Identity Label. This label should be affixed to the inside of the front door of the control chassis, beneath the large wiring guide.
6. Verify presence of optical tamper reflector on the inside of the chassis door.
7. OPTIONAL: Install the physical tamper switch in the chassis.
 - a) Install the tamper switch in the chassis by removing the hex collar, seating the switch inside the provided mounting bracket, and reattaching and tightening the hex collar.

Switch SW 7 setting description

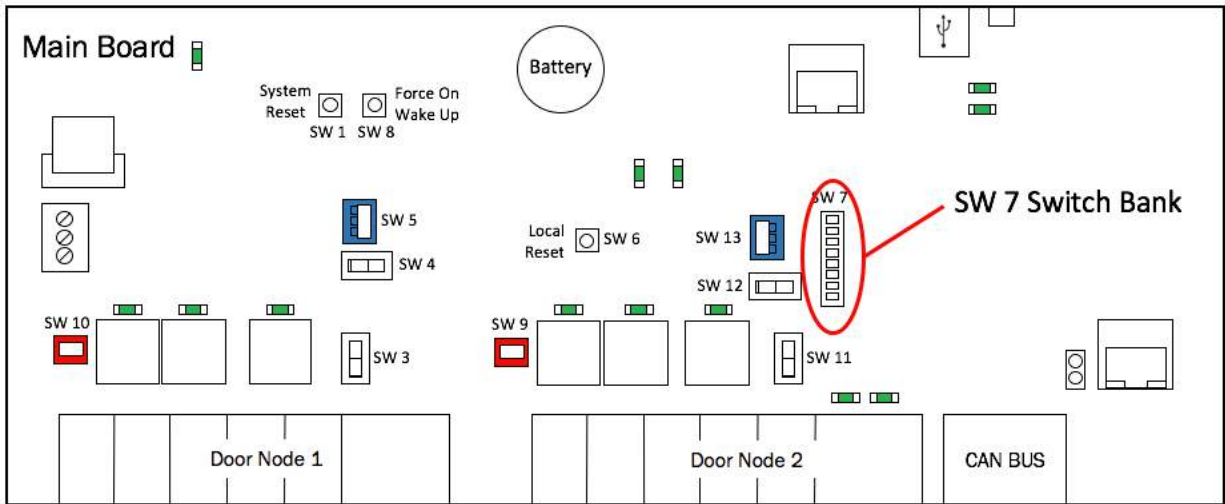

Figure 1 - ACS6000 SW 7 Switch Bank Location

SW 7 – System Settings

	Off	On	
Enabled	◀	Tamper ▶	Disabled
Disabled	◀	CAN Term ▶	Enabled
	SW 7 - 3		
	SW 7 - 4		
	SW 7 - 5		
Disabled	◀	Factory Reset ▶	Enabled
Disabled	◀	Diagnostic ▶	Enabled
Enabled	◀	Wi-Fi ▶	Disabled

Figure 2 - ACS6000 SW 7 Switch Settings

Switch Setting	Description	Functionality Description
SW 7-1	<i>Tamper</i>	<i>Enabled:</i> Tamper functionality is in use <i>Disabled:</i> Tamper functionality is not in use
SW 7-2	<i>CAN Bus</i>	<i>Enabled:</i> CAN Bus is terminated <i>Disabled:</i> CAN Bus is not terminated
SW 7-3		
SW 7-4	<i>Maintenance Mode</i>	For general operation, SW 7-4 needs to be in the Off position.
SW 7-5		
SW 7-6	<i>Factory Reset</i>	How to perform factory reset: <ul style="list-style-type: none"> • Ensure that SW 7-6 is in the OFF position. • Power off MAIN BOARD. • Place SW 7-6 dip switch in the ON position • Power on the board and wait until you hear two two-second long beeps and see the main heartbeat LED turn off. • Within 10 seconds of hearing the beeps, place SW 7-6 dip switch back into the OFF position. • You will hear a one second-long beep and the main heartbeat LED will start blinking again indicating the system is performing a factory reset. • After the factory reset is complete, you will hear 2 short beeps. • At this point, the factory reset is complete the system will now run with factory default firmware.
SW 7-7	<i>Diagnostic</i>	<i>Enabled:</i> MCU Full Debug <i>Disabled:</i> MCU Standard Debug
SW 7-8	<i>Wi-Fi</i>	<i>Enabled:</i> Wi-Fi can be used if configured. <i>Disabled:</i> Wi-Fi cannot be used at all, even if configured.

Connect the MAIN BOARD and all expansion boards to a power supply board

1. Connect the MAIN BOARD in the control chassis to the power supply board.

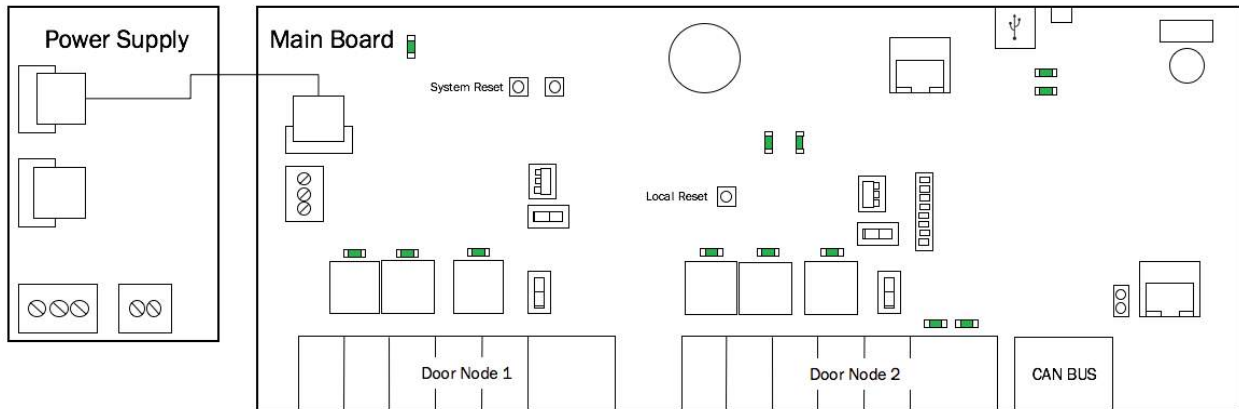

Figure 3 - Connect MAIN BOARD to Power Supply

2. If there is a DOOR BOARD or an INPUT OUTPUT BOARD in the control chassis, connect that to the power supply board.

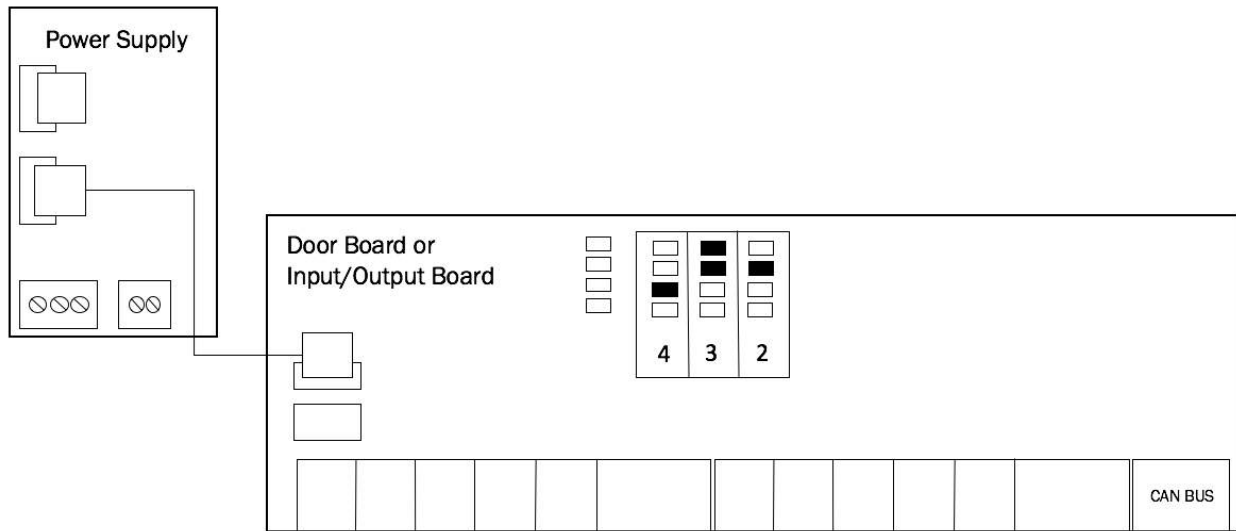



Figure 4 - Connect Expansion Board to Power Supply

3. If there are expansion chassis, connect each DOOR BOARD and INPUT OUTPUT BOARD to the power supply board in each chassis.
 - a) Use the power cable that came with each circuit board kit.
 - b) The Power connector uses a PC-style 4-wire molded (Molex) connector to deliver +12V, Ground, Power Detection, and Earth Ground to each board from the power supply.

	<p>WARNING: Power Supply</p> <p>DO NOT USE ANY POWER SUPPLY OTHER THAN THOSE SUPPLIED WITH YOUR BRIVO PRODUCT.</p>
---	---

	<p>WARNING: Powering Electronic Strikes and Latches</p> <p>DO NOT POWER ELECTRONIC STRIKES AND LATCHES WITH THE BATTERY (OR OTHER POWER SOURCE) USED TO POWER THE CONTROL PANEL; DOING SO WILL CAUSE DAMAGE TO THE BRIVO CONTROL PANEL. USE ONLY A UL LISTED BURGLAR ALARM OR ACCESS CONTROL SYSTEM TO POWER ELECTRONIC STRIKES AND LATCHES.</p>
---	---

The ACS6000 control panel Tamper On/Off Toggle in the off position deactivates both optical and physical tamper switches.

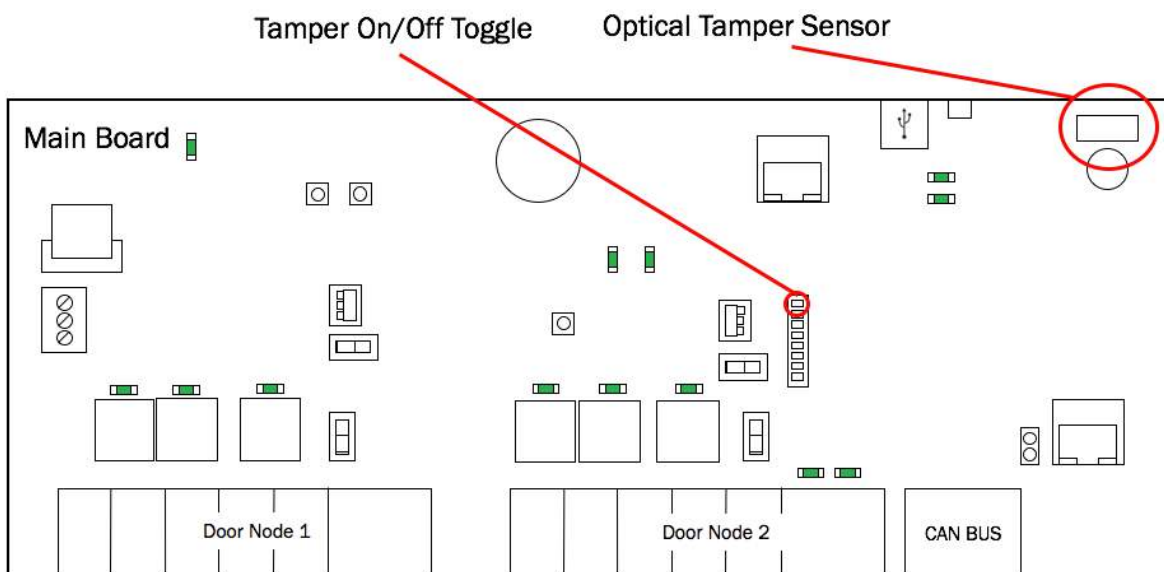



Figure 5 - Tamper Switch and Optical Tamper Sensor Locations

	<p>NOTE: If the technician is installing the ACS6000 MAIN BOARD as a retrofit in an ACS5000 enclosure, there is no optical reflector present. The optical tamper will not function.</p>
---	--

OPTIONAL: Connect the physical tamper switch to the MAIN BOARD and to one board in each expansion chassis.

1. Connect the physical tamper switch to the MAIN BOARD in the control chassis.

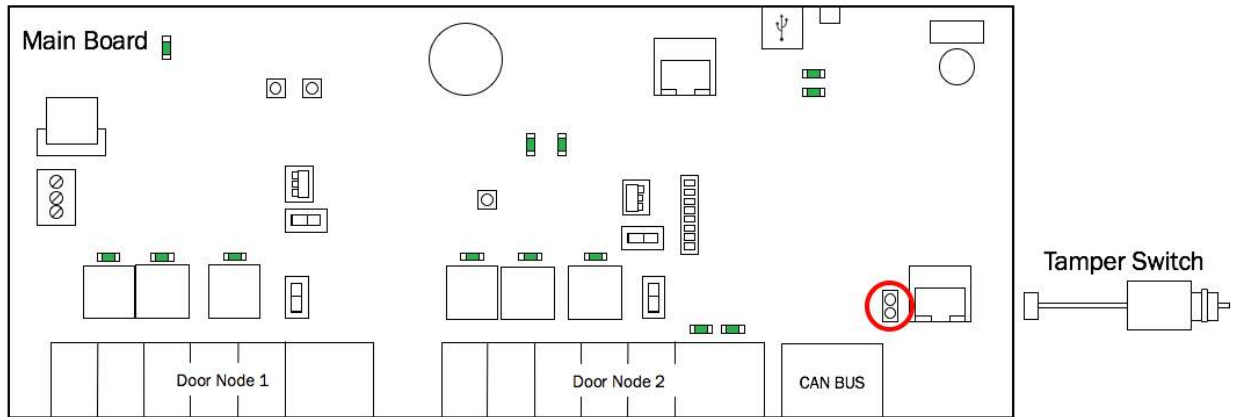

Figure 6 - Connect Tamper Switch to MAIN BOARD

- a) The tamper header connects to the supplied tamper switch.
 - b) The header connector for the tamper switch should be connected to the TAMPER pins located on the lower right side of the MAIN BOARD and each expansion board.
2. Connect the tamper switch to one expansion board (DOOR BOARD or INPUT OUTPUT BOARD) in each expansion chassis.

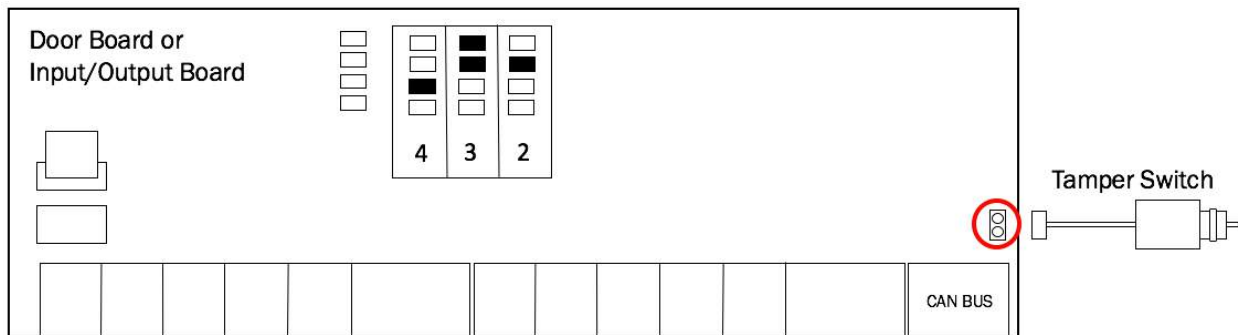

Figure 7 - Connect Tamper Switch to Expansion Board

i **NOTE:** If a chassis has two boards, connect the tamper switch to the upper board.

i **NOTE:** If the tamper switch is not going to be used, leave the supplied jumper on this connector to keep the circuit closed.

Connect the battery leads to the power supply

! **WARNING: Backup Battery**
 DO NOT CONNECT THE BACK-UP BATTERY AT THIS TIME. *Premature connection of the battery terminals may cause damage to the control panel.*

1. Connect the battery wires that come with each circuit board kit to the power supply BATTERY INPUT terminal block.
 - a) Connect the black wire to the ground (GND) terminal.
 - b) Connect the red wire to the +12V terminal.
 - c) Make sure the battery wires are segregated at least $\frac{1}{4}$ inch away from all other input/output wiring.

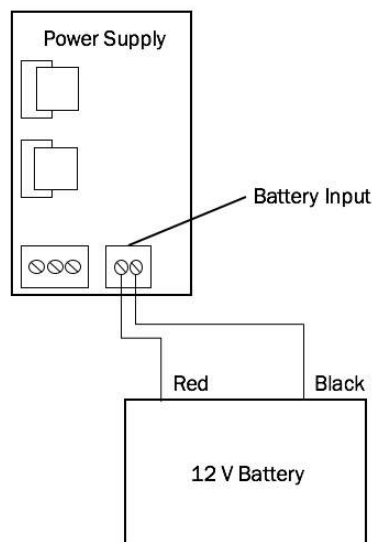
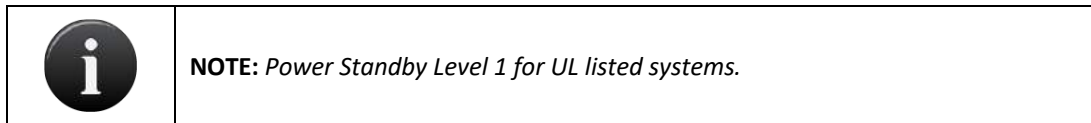



Figure 8 - Connect Battery Leads to Power Supply

Wire the AC/DC transformer to the power supply

	<p>WARNING: Transform Connection</p> <p>DO NOT CONNECT THE TRANSFORMER TO A SWITCHED OUTLET OR OTHERWISE CONTROLLED AC OUTLET.</p> <p>DO NOT CONNECT THE TRANSFORMER TO THE 120 VAC OUTLET UNTIL ALL WIRING IS COMPLETED.</p>
---	--

- The transformer block comes pre-wired with 10 feet of cable. If an extension is needed, use 18 AWG wire (minimum grade) to connect to the 16VAC/19VDC POWER INPUT terminal block on the power supply board, using terminals DC +/AC1 and DC -/AC2.

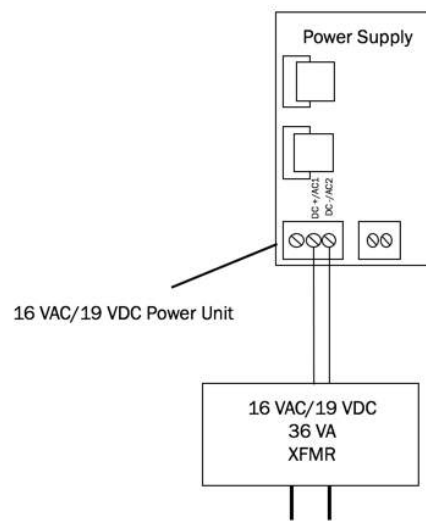

Figure 9 - Connect AC Transformer to Power Supply

- To maintain UL compliance, the unit must be powered by a UL 294 Listed power supply capable of supplying 16VAC/19VDC, 2.1A to the power supply board.

Model	Circuit	Voltage (VDC/AC)	Current (mA/A)
Brivo ACS6000-A/ACS6008-A Brivo ACS6000-E/ACS6008-E	Input	120/240VAC (Primary) (This voltage is supplied to the wall transformer and not directly to any PCBs inside of the chassis)	0.49A/1.0A
		19VDC (Secondary)	1.89A (DC)
		16VAC (Secondary)	2.25 A (RMS)

Installation Procedures

Establish CAN BUS Wiring

i **NOTE:** The ACS6000 and ACS6008 chassis include a pre-assembled CAN Bus connection cable. This cable should be used for connecting panels within the same chassis. The ACS6000 chassis include a 2-board connection cable, and the ACS6008 includes a 4-board connection cable. The installer must still manually wire connections between each individual chassis.

i **NOTE:** The ACS6000 enclosure CAN Bus cable has three connectors. If connecting an ACS6000 mainboard to a door/IO board, use the smaller connector at one end of the cable for the mainboard, and the first middle larger connector for the door/IO board. If connecting two door/IO boards, use the first and second larger board connectors. In an ACS6008 enclosure, you have the option to connect a mainboard to three door/IO boards or to connect four door/IO boards together using the provided pre-assembled CAN Bus cable. Upon completion, there will be an extra connector (either a mainboard connector or a door board/IO connector at one end of the cable assembly). The installer may cut this connector off should they deem it necessary.

1. If there is an expansion board in the control chassis, connect it to the MAIN BOARD.

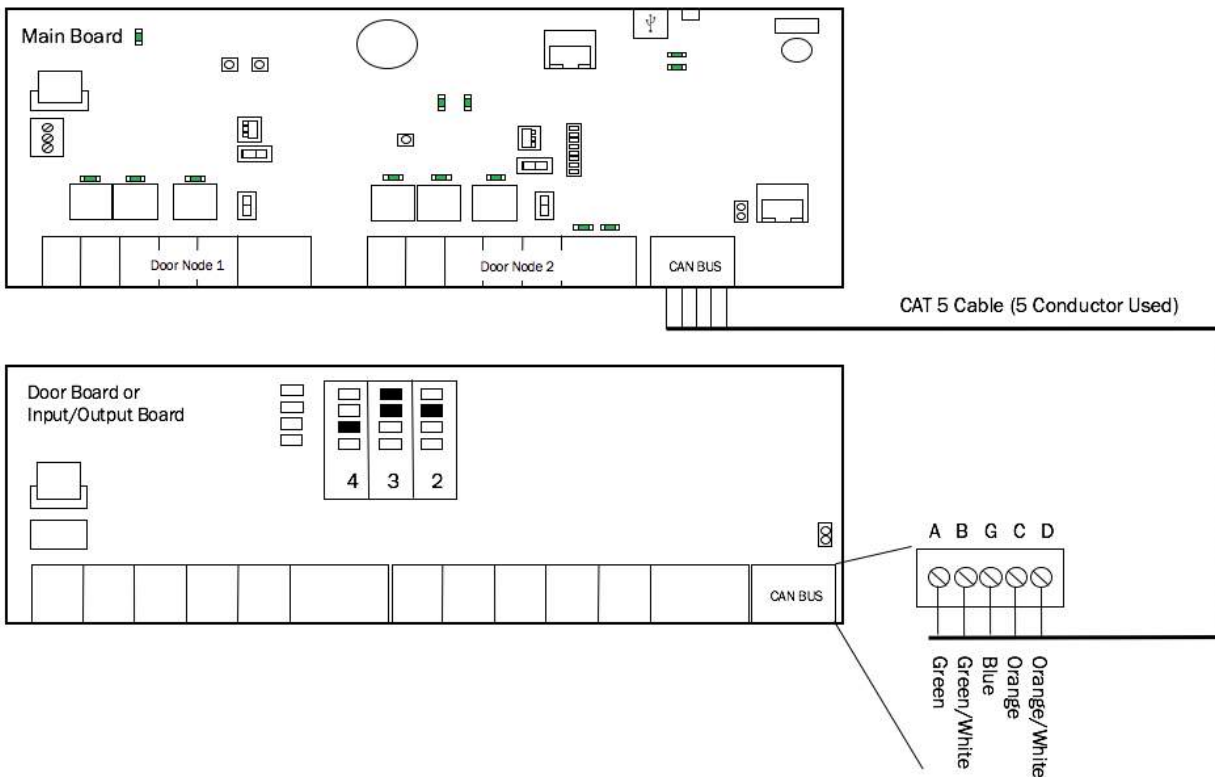

Figure 10 - Connect Expansion Board to MAIN BOARD

2. If there are expansion chassis, in each chassis connect the second expansion board to the first one.

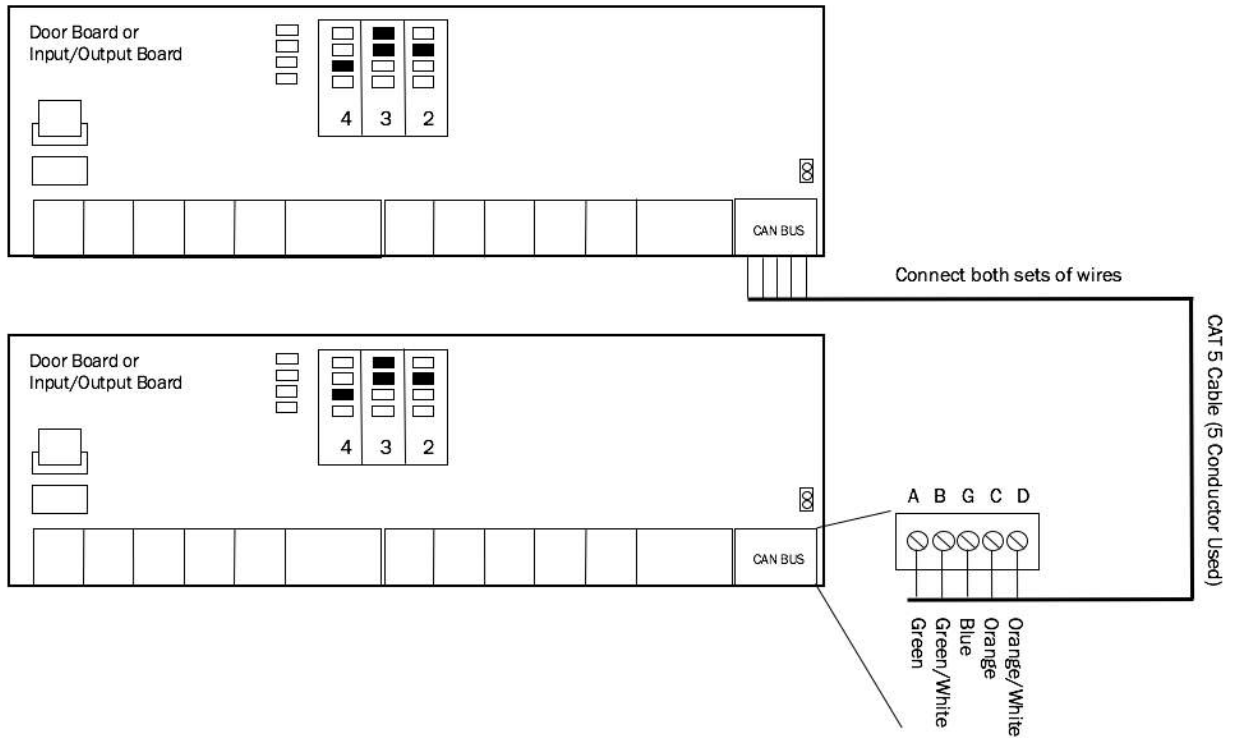

Figure 11 - Connect Expansion Boards in Expansion Chassis

3. Daisy-chain the complete set of chassis together.
 - a) For example, if there are six boards in the control panel, there would be a MAIN BOARD and five expansion boards (E1, E2, E3, E4, and E5). Each expansion board could be either a DOOR BOARD or an INPUT OUTPUT BOARD.
 - b) To daisy-chain the boards together: (See Figure 11 below.)
 - Wire E5 to E4 in Expansion Chassis 2.
 - Wire E4 in Expansion Chassis 2 to E3 in Expansion Chassis 1.
 - Wire E3 to E2 in Expansion Chassis 1.
 - Wire E2 in Expansion Chassis 1 to E1 in the Control Chassis.
 - Wire E1 to the MAIN BOARD.

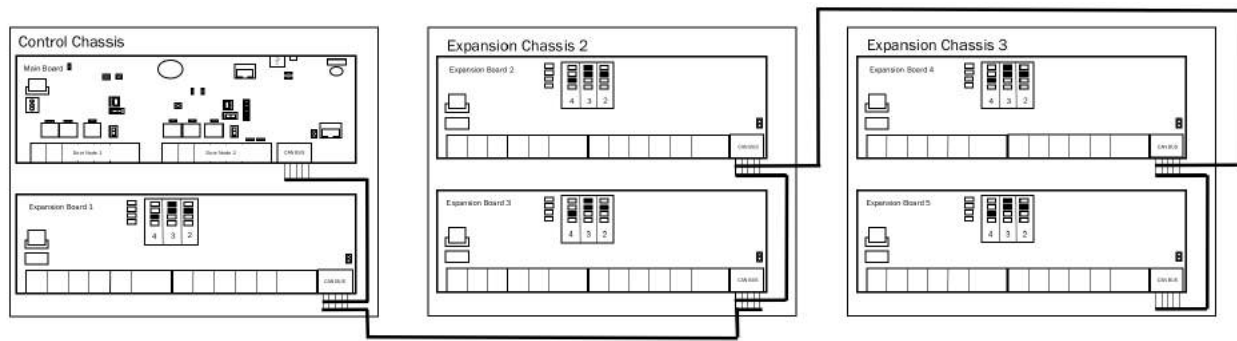

Figure 12 - CAN BUS Configuration

4. Use standard CAT5 or CAT6 (unshielded twisted pair) cabling to connect all the boards in the control panel via the CAN BUS terminals.
5. Always connect like terminals to one another (i.e., A to A, B to B, and so on.).
6. Follow the color coding shown on the wiring diagram on the inside of the chassis door.

	<p>WARNING: CAN BUS Wiring</p> <p>THE A/B CIRCUITS MUST SHARE A TWISTED PAIR, AND THE C/D CIRCUITS MUST SHARE A TWISTED PAIR. Otherwise, the distance and data integrity of the communications channel will be compromised.</p> <p>WHEN USING JUST A MAIN BOARD, SWITCH SW 7-2 TO THE ON POSITION WHICH ENABLES CAN TERMINATION ON THE MAIN BOARD. <i>If expansion boards are used, the can termination jumper remains attached on the first and last board(s) in the daisy chain; i.e. It must be removed from all boards except the endpoint of the daisy chain. (NOTE: The MAIN BOARD does not have to be an endpoint in the control panel; the control panel may be in the middle of the chain with expansion boards branching out in either direction.)</i></p>
--	---

7. On the first board, connect the wires of the CAT5/CAT6 cable to the CAN BUS terminal block as follows:
 - a) Connect the green wire to the A terminal.
 - b) Connect the green and white wire to the B terminal.
 - c) Connect the blue wire to the G (ground) terminal.
 - d) Connect the orange wire to the C terminal.
 - e) Connect the orange and white wire to the D terminal.
8. After all the wires of the CAT5/CAT6 cable are connected to the first board, connect the wires to the second board in the same manner.
9. Connect the CAN NODE ADDRESS jumpers. The silkscreen next to the CAN NODE ADDRESS pins shows how to position the jumpers for first four addresses.
10. Positions for additional address values are shown in the diagram below.

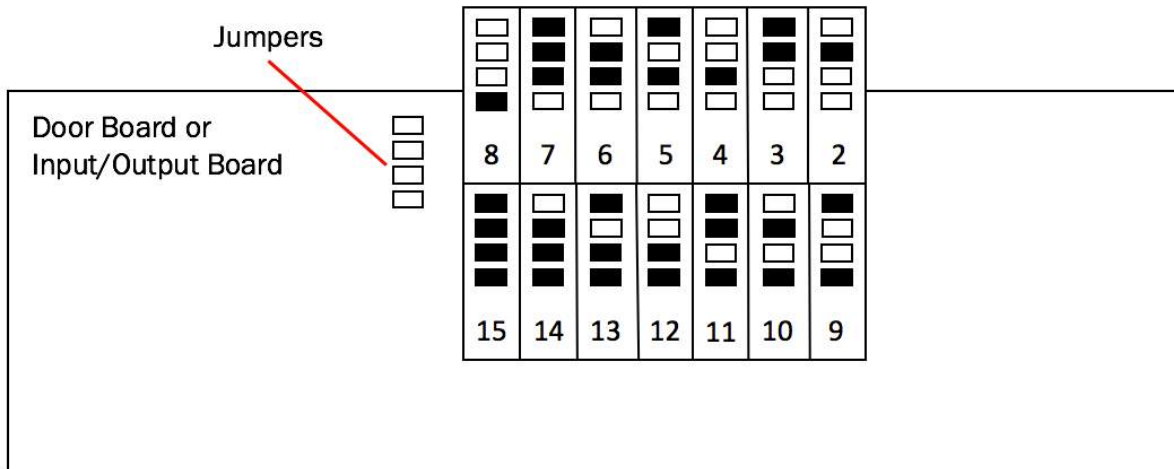



Figure 13 - CAN NODE ADDRESS Jumpers

	<p>WARNING: CAN BUS Wiring</p> <p>The CAN NODE ADDRESS jumpers are used to set the address of each board on the CAN BUS. DO NOT ASSIGN TWO BOARDS THE SAME ADDRESS, OR THE BUS WILL NOT FUNCTION PROPERLY.</p> <p>Set these values sequentially, starting with 2 as the first expansion board address; address 1 is the MAIN BOARD. Record all addresses on the Installation Worksheet. These jumper settings will map to board numbers when the control panel is configured via the application.</p>
--	--

Wire Doors

For each board node to be used for controlling a door, as indicated in the completed *Installation Worksheet*, make the following connections.

NOTE: Doors can be wired to the MAIN BOARD or to expansion boards, including both DOOR BOARDS and INPUT OUTPUT BOARDS.

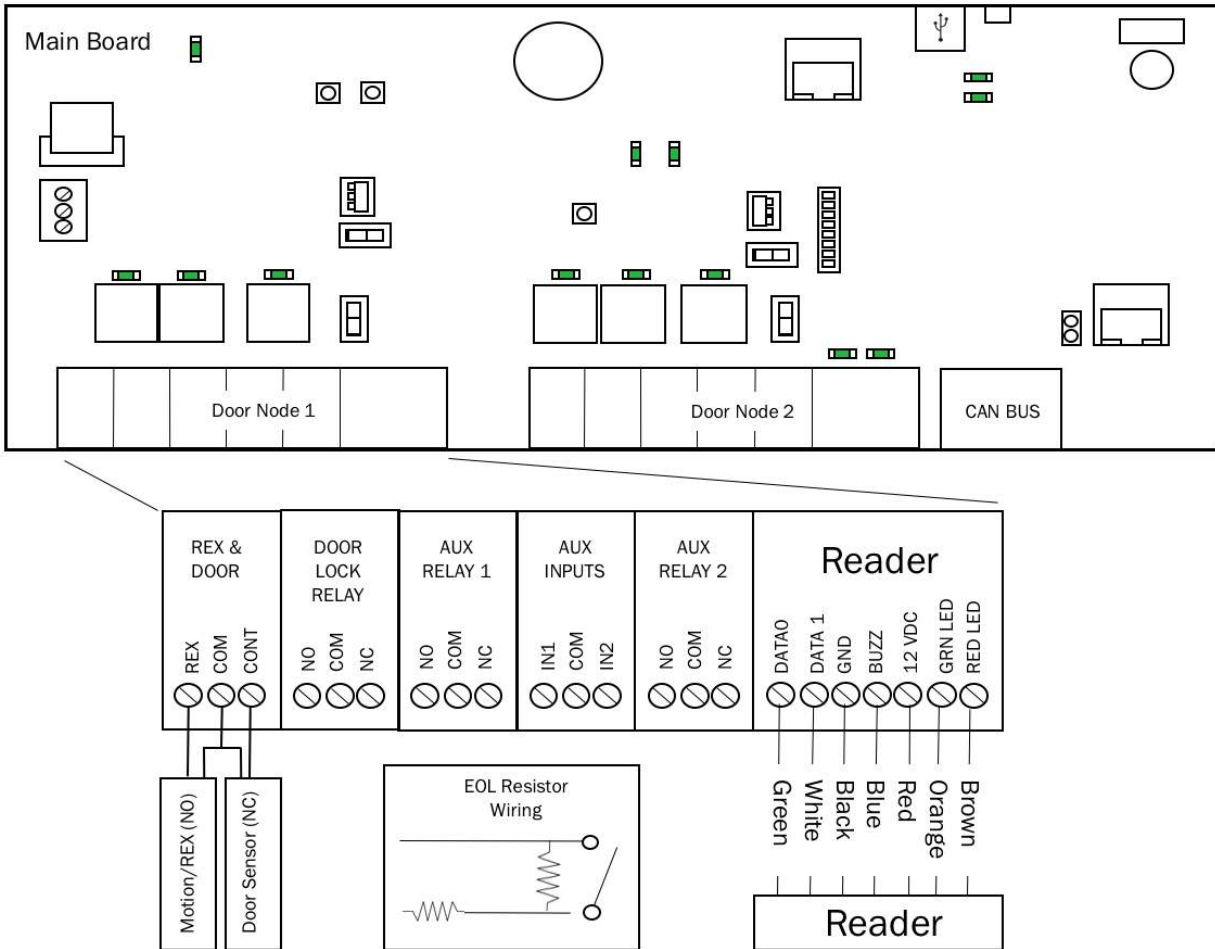

Figure 14 - Wire Doors for Wiegand Readers

NOTE: ACS6000 Output Ratings for the ACS6000 Main Board

- Two (2) reader ports, 12V, 350mA each
- Two (2) selectable wet contacts, 12VDC, 350mA each
- Four (4) dry contacts are 28VDC, 6A each



NOTE: ACS6000 Output Ratings for the Door Board

- Two (2) reader ports, 12V, 300mA **COMBINED for both readers.**
- Six (6) relays on the Door Board. The ratings are 24VDC, 3A each.

1. Wire the REX & DOOR terminal block.
 - a) Connect the Normally Open (NO) contacts of the REX device to the REX and COM terminals.
 - When this switch closes, it initiates a Request-to-Exit (REX) program sequence, as defined by the appropriate application, including the option to activate the door or other relays, fire the door strike, and suppress any “Door Forced” messages.
 - b) Connect the Normally Closed (NC) contacts of the Door Sensor to the COM and CONTACT terminals.
 - In this context, an NC switch is considered closed when the door is closed (magnet is present), and open when the door is open (no magnet is present).
 - When the switch is open, the control panel interprets this input as a “Door Open” condition. When the switch is closed, the control panel interprets this input as a “Door Closed” condition.
 - This circuit provides door status information (open/closed) to the control panel so the application can take appropriate action locally, or send email notifications if necessary.
2. Wire the DOOR LOCK RELAY terminal block.
 - a) Connect the door latch to the COM terminal and either the NO or NC terminal.
 - b) The DOOR LOCK RELAY provides both NO (Normally Open) and NC (Normally Closed) contacts, and is driven in response to the presentation of valid credentials or the programmable REX input.
 - c) Timing and other aspects of relay activation are programmed through the application.
3. If used for an alarm shunt, wire the AUX RELAY 1 terminal block. If not used for an alarm shunt, AUX RELAY 1 can be used for a variety of purposes.
4. Wire AUX RELAY 2. Like the AUX RELAY 1, this terminal block can be used for a variety of purposes, and are programmed via the application.



NOTE: *The fully programmable AUX RELAYs provide both NO (Normally Open) and NC (Normally Closed) contacts.*



WARNING: Relay Amp Limit

THERE IS A 3A, 24VDC LIMIT ON THROUGH CURRENT FOR ALL RELAYS.

5. If used, wire the AUX INPUTS terminal block.
 - a) The IN1 and IN2 terminals are contact closure type inputs that share a COM terminal.
 - b) The terminals can be used for a variety of purposes, and are programmed through the application.
6. Wire the Reader terminals to the last block of terminals in this door node.

	<p>NOTE: To activate RS-485 functionality on the ACS6000 MAIN BOARD for Door 1, put the RS-485/Wiegand Door 1 switch in the RS-485 position. For Door 2, put the RS-485/Wiegand Door 2 switch into the RS-485 position.</p> <p>To activate Wiegand functionality on the ACS6000 MAIN BOARD for Door 1, put the RS-485/Wiegand Door 1 switch in the Wiegand position. For Door 2, put the RS-485/Wiegand Door 2 switch in the Wiegand position.</p>
---	---

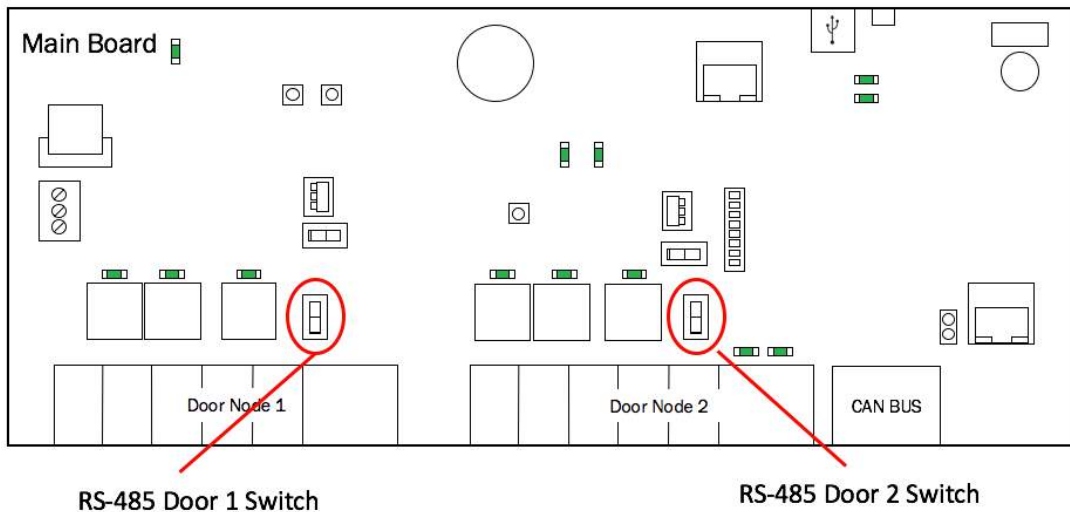



Figure 15 - RS-485/Wiegand Switch Locations

	<p>NOTE: The ACS6000 board defaults to Half-Duplex communication when using RS-485 reader functionality. In order to switch to Full-Duplex communication, move the Door 1 FDX/HDX switch on Door 1 and Door 2 FDX/HDX switch on Door 2 to the Full-Duplex position.</p> <p>If placing into Full-Duplex mode, be careful as most readers will typically operate in Half-Duplex mode.</p>
---	--

i **NOTE:** To activate Full Duplex functionality on the ACS6000 MAIN BOARD for Door 1, put the FDX/HDX Door 1 switch in the FDX position. For Door 2, put the FDX/HDX Door 2 switch into the FDX position.

To activate Half Duplex functionality on the ACS6000 MAIN BOARD for Door 1, put the FDX/HDX Door 1 switch in the HDX position. For Door 2, put the FDX/HDX Door 2 switch in the HDX position.

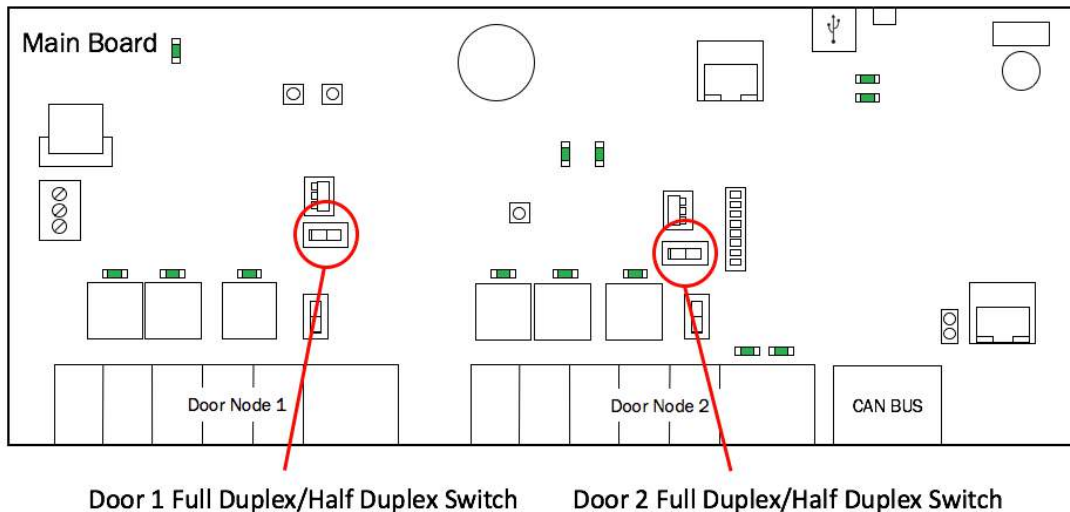

Figure 16 - RS-485 Full Duplex/Half Duplex Switch Locations for Doors 1 and 2

i **NOTE:** RS-485 bus requires termination. Door 1 RS-485 Term is the RS-485 Door 1 bus termination switch and Door 2 RS-485 Term is the RS-485 Door 2 bus termination switch.

To enable RS-485 bus termination for Door 1, put the RS-485 termination switch in the Enabled position. To enable RS-485 termination for Door 2, put the RS-485 termination switch in the Enabled position.

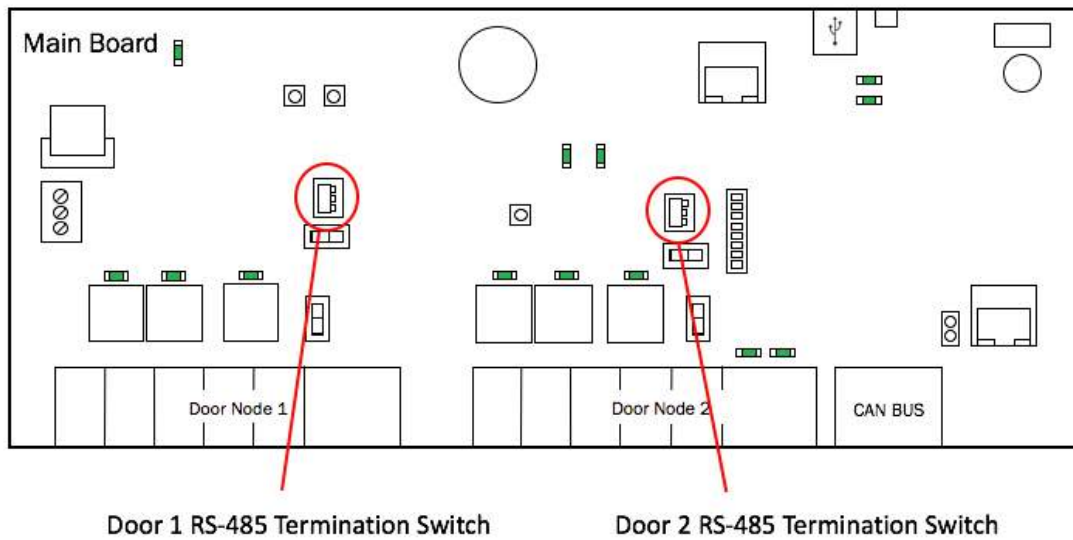



Figure 17 - RS-485 Termination Switch Locations for Doors 1 and 2

	<p>NOTE: Door lock relays can be provided with power by using Door 1 Wet/Dry Switch above Door Node 1 and Door 2 Wet/Dry Switch above Door Node 2.</p> <p>To enable wet mode for Door 1, put the Door 1 Wet/Dry Select Switch in the Wet position. To enable wet mode for Door 2, put the Door 2 Wet/Dry Select Switch in the Wet position.</p> <p>To enable dry mode for Door 1, put the Door 1 Wet/Dry Select Switch in the Dry position. To enable dry mode for Door 2, put the Door 2 Wet/Dry Select Switch in the Dry position.</p>
--	---

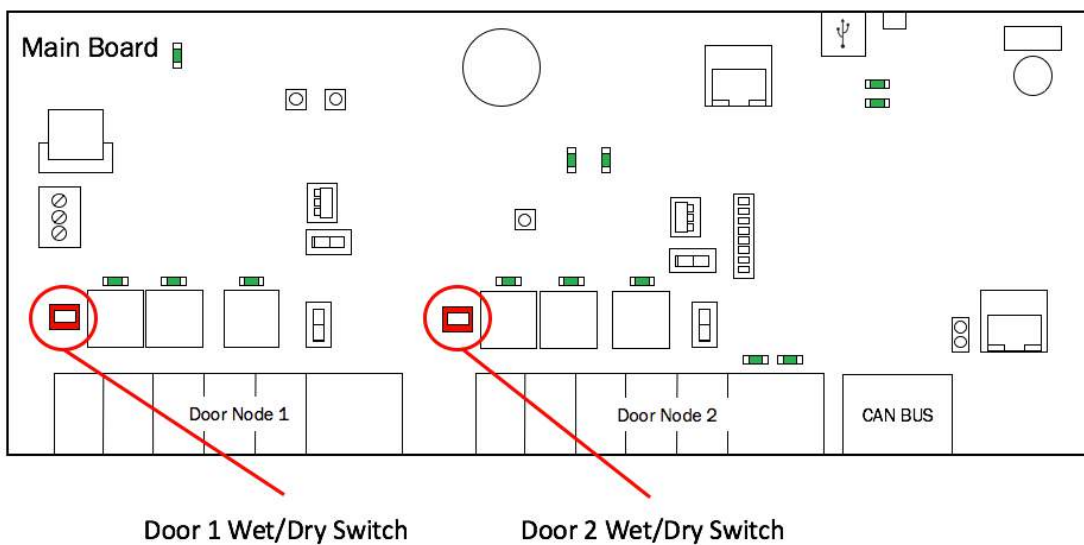

Figure 18 - ACS6000 Wet/Dry Door Contact Switches for Doors 1 and 2



NOTE: Refer to our Approved Wiegand and OSDP Reader List and connection diagrams.

- a) Use the wire recommended by the manufacturer of the reader or keypad. If no wire is recommended, use a minimum of 22 AWG wire with sufficient conductors that include shield (drain).
- b) If your reader interface uses standard Wiegand conventions, connect the wire properly to the terminal block on the appropriate board node. Following is a typical, *but not universal*, wiring guide. Refer to our Approved Wiegand and OSDP Reader List for guidelines related to your specific reader or keypad.
 - Connect the green reader wire to the DATA0 terminal. This is the standard Data 0 circuit for Wiegand readers.
 - Connect the white reader wire to the DATA1 terminal. This is the standard Data 1 circuit for Wiegand readers.
 - Connect the black reader wire to the GND terminal. This is the standard Ground circuit for the reader.
 - Connect the blue reader wire to the BUZZ terminal. This is the standard Buzzer circuit for the reader.
 - Connect the red reader wire to the 12VDC terminal. This provides +12VDC to power the reader.
 - Connect the orange reader wire to the GRN LED terminal. This is the green LED circuit.
 - Connect the brown reader wire to the RED LED terminal. This is the red LED circuit.
- c) If your reader is OSDP using RS-485 wiring conventions, connect the wire properly to the terminal block on the appropriate board node. Following is a typical, *but not universal*, wiring guide. Refer to our Approved Wiegand and OSDP Reader List for guidelines related to your specific reader or keypad.
 - Connect the wire to the RXD+ terminal. This is the standard RXD+ circuit for OSDP readers using RS-485.
 - Connect the wire to the RXD- terminal. This is the standard RXD- circuit for OSDP readers using RS-485.
 - Connect the wire to the GND terminal. This is the standard Ground circuit for OSDP readers using RS-485.
 - Connect the wire to the 12VDC terminal. This provides +12VDC to power OSDP readers using RS-485.

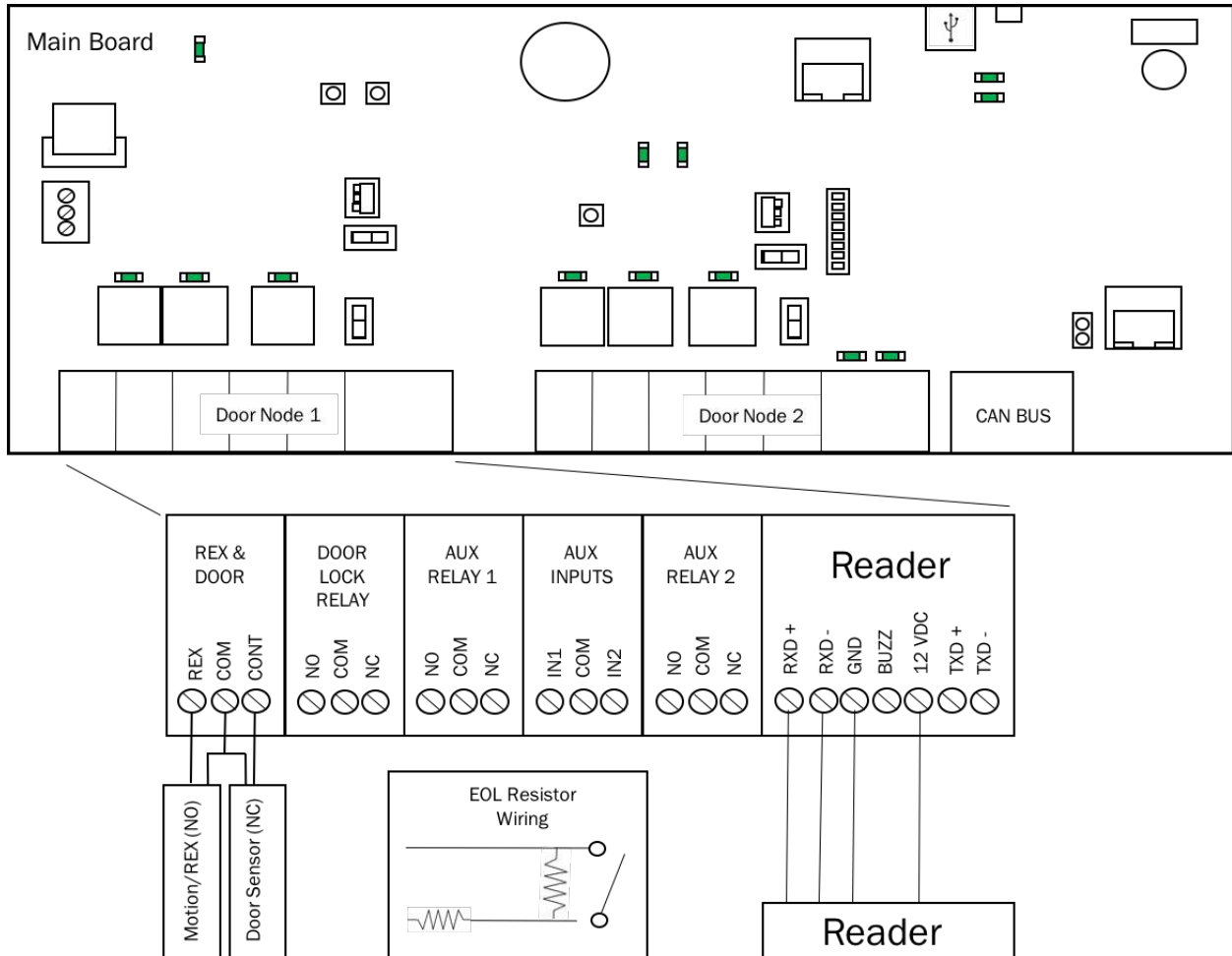



Figure 19 - Wire Doors for OSDP Readers using RS-485

7. Install MOVs.

	<p>WARNING: Noise Suppression</p> <p>INSTALL THE TRANSIENT NOISE SUPPRESSION DEVICE (MOV) SUPPLIED WITH THE CONTROL PANEL.</p>
---	---

- a) Install the MOV across the conductors, as close as possible to the electric strike or latch. This will normally be at the connection from the field-installed wiring to the pig tail or screw terminals of the electronic strike or latch.
- b) Use the wire recommended by the manufacturer of the electric strike or latch. If no wire is recommended, use a minimum of 18 AWG wire with sufficient strands for the specific electronic strike or latch.

Wire INPUT OUTPUT BOARDS

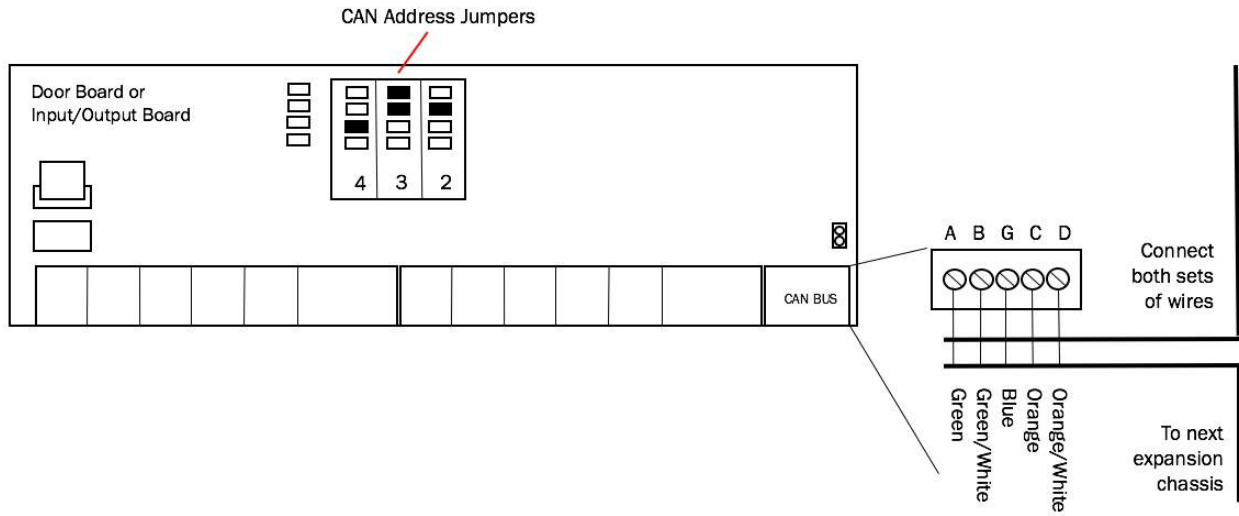



Figure 20 - Wire INPUT OUTPUT BOARD

	<p>NOTE: ACS6000 Output Ratings for the Input Output Board</p> <ul style="list-style-type: none"> • Eight (8) relays on the I/O Board. The ratings are 24VDC, 3A each.
---	--

1. An INPUT OUTPUT BOARD has 8 output relays and 8 inputs. The inputs can be wired for line supervision.
2. The ACS6000 control panel is capable of 4-state input monitoring at each input connector, whether it be on the Main Board, a Door Board, or an Input Output Board. This allows for monitoring of not only open and closed switches, but cut and short-circuited lines as well. This can only happen when the EOL (end-of-line) resistor wiring is installed.
 - a) You will need two 2K ohm resistors for each input.
 - b) The resistors are installed on the input lines as close to the switch as possible, and as far from the ACS6000 control panel.
 - c) One resistor is placed in parallel with the switch, so that one end of the resistor is connected to wire 1 from the switch, while the other end is connected to wire 2 from the switch.
 - d) The second resistor is placed in series with the switch, so that one end of the resistor is connected to wire 1 from the switch, while the other end is connected to the wire leading to the ACS6000 control board.
 - e) The other wire from the ACS6000 is connected to wire 2 from the switch, as shown in Figure 21.

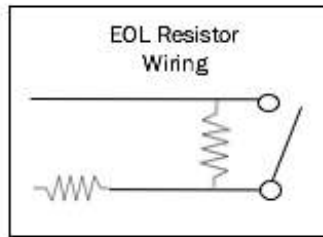

Figure 21 - EOL Resistor Wiring

	<p>WARNING: Powering Electronic Strikes and Latches</p> <p>DO NOT POWER ELECTRONIC STRIKES AND LATCHES WITH THE BATTERY (OR OTHER POWER SOURCE) USED TO POWER THE CONTROL PANEL; DOING SO WILL CAUSE DAMAGE TO THE BRIVO CONTROL PANEL. USE ONLY A UL LISTED BURGLAR ALARM OR ACCESS CONTROL SYSTEM TO POWER ELECTRONIC STRIKES AND LATCHES.</p>
--	---

Mount and connect the ACS6000 Wi-Fi antenna (if using Wi-Fi functionality)

**NOTE: Wi-Fi Frequency**

Wi-Fi on the ACS6000 panel operates in the 2.4GHz frequency bands.

1. If you are using the Wi-Fi functionality of the ACS6000 board, please make certain that your SW 7-8 Wi-Fi switch is set to the Enabled position.
2. Included in the shipping contents of the ACS6000 panel is a Wi-Fi antenna cable with one end being a brass washer/screw connector (which is covered by a removable red protective cover) and the other end being a silver snap connector.
3. Unscrew the brass washer from the cable and place that end through the top of the chassis. Now screw the washer back in place on the outside of the chassis, securing the cable to the top of the chassis.
4. Attach the Wi-Fi antenna (included with the shipping contents) to the connector atop the chassis.

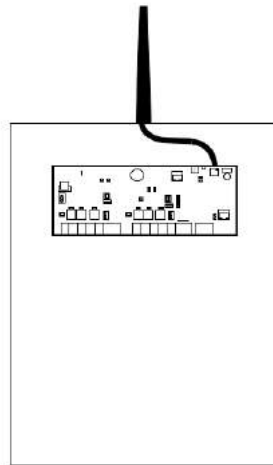

Figure 22 - ACS6000 Wi-Fi Cable Connection

5. Attach the silver end of the Wi-Fi integrated circuit antenna connector located in the upper right hand corner of the Wi-Fi antenna chip on the ACS6000 MAIN BOARD.



Figure 23 – Wi-Fi Integrated Circuit Antenna Connector

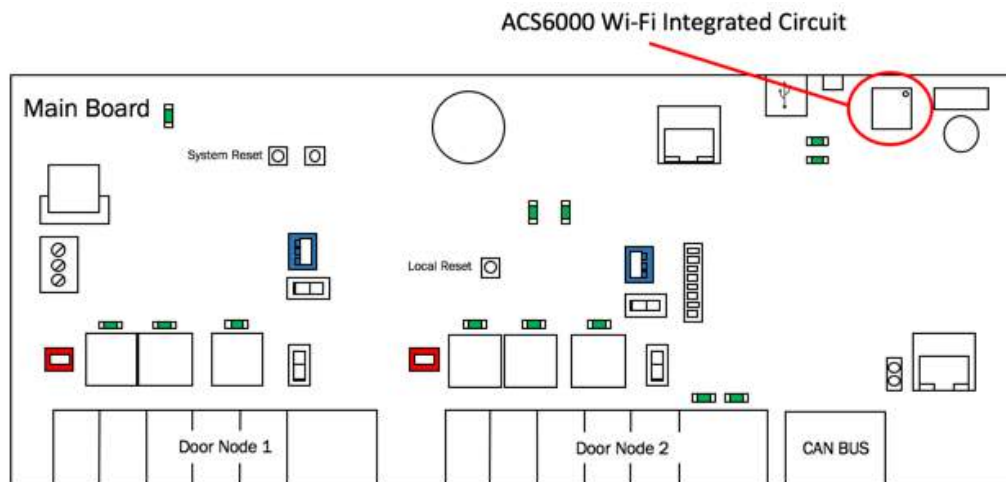



Figure 24 - ACS6000 Wi-Fi Integrated Circuit Location

6. When snapped into place, you may feel and hear an audible click.

Ground the control chassis.

1. Wire the incoming Earth ground cable to the control chassis Earth ground screw located at the bottom of the chassis.
2. Use 18 AWG or larger wire to connect the chassis to a suitable earth ground.
3. The ground contact point is in the lower panel area, near the hinge for the door and in front of the power supply.

POWERING AND TESTING PROCEDURES

	<p>WARNING: Power Precautions</p> <p><i>BEFORE POWERING UP THE CONTROL PANEL, CHECK THE FOLLOWING CONNECTIONS. MAKE SURE THAT:</i></p> <ul style="list-style-type: none"> • <i>The transformer is NOT plugged into the 120VAC outlet.</i> • <i>All wiring to the back-up battery is DISCONNECTED.</i>
---	--

Power up the control panel.

1. Plug the transformer into a 120VAC outlet.
2. Check ALL power indicators:
 - a) Once the chassis door is closed, check the power supply board through the clear viewing hole to confirm that the green LED is on, indicating that AC power is being supplied to board and that the board is producing 12VDC power.
 - b) Check the MAIN BOARD to confirm that the LOCAL HRTBT (local heartbeat) and MAIN HRTBT (main heartbeat) have come on and are blinking.
 - The local heartbeat should begin blinking immediately.
 - The main heartbeat can take 30-60 seconds to establish a steady beat.

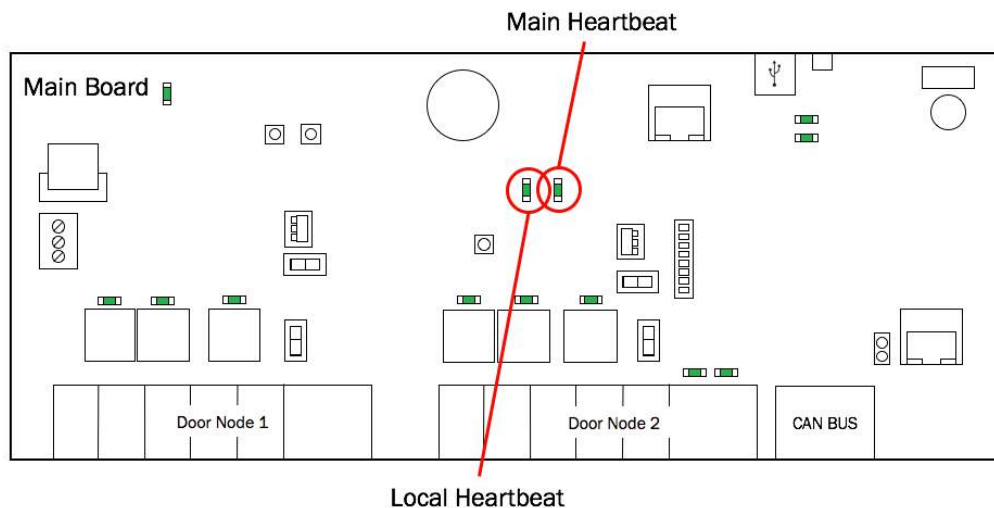

Figure 25 - MAIN BOARD Heartbeats

- c) Check each DOOR BOARD to confirm that the LOCAL HRTBT has come on and is blinking, indicating that 12 VDC power is present.

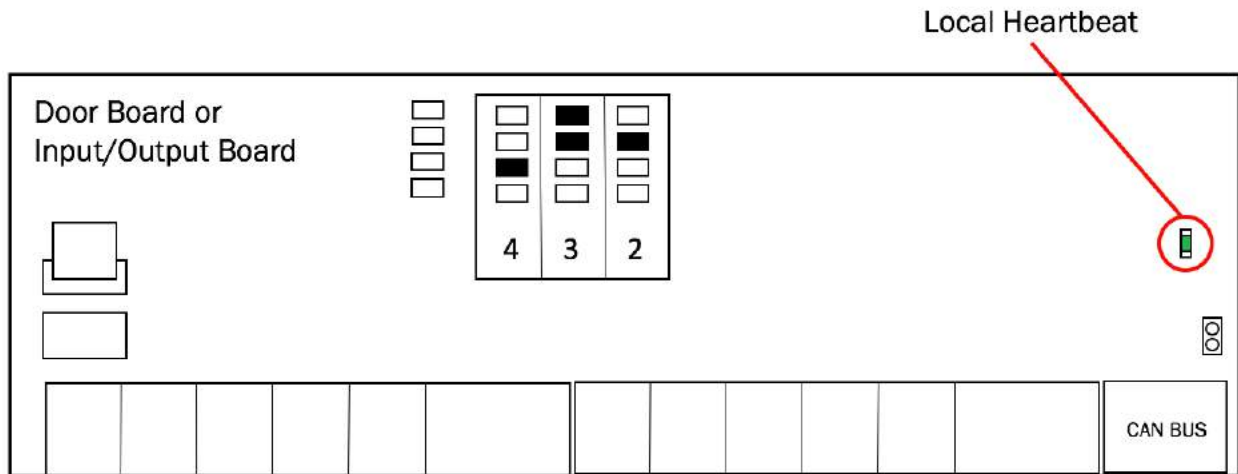



Figure 26 - Expansion Board Local Heartbeat

- d) Check each INPUT OUTPUT BOARD to confirm the LOCAL HRTBT has come on and is blinking.
- e) If any of these power indicators is not correct (i.e., the LED light does not come on or does not begin blinking, check the connections from the power supply to each of the circuit boards. If all connections are good but there is a still a problem with the power indicator, contact Technical Support.

	<p>NOTE: A steady light is an indication of a problem, just as much as no light is.</p>
---	--

- 3. If ALL power indicators are correct, attach the back-up battery and check that ALL indicators remain the same.

CONFIGURATION PROCEDURES

Connect a laptop to the MAIN BOARD's ADMIN Port (if required)

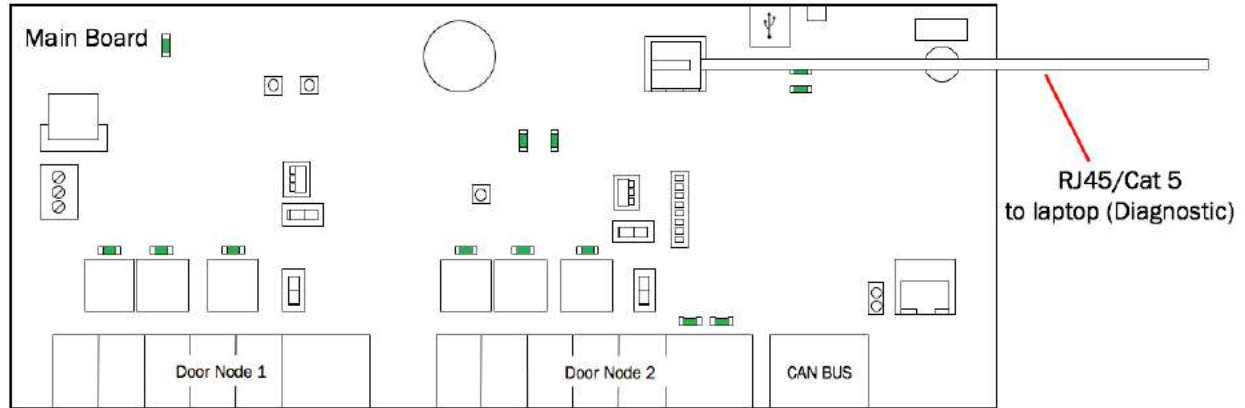

Figure 27 - Connect Laptop to MAIN BOARD

1. Connect a laptop to the ADMIN port on the MAIN BOARD using a standard Ethernet cable or a patch cable.
 - a) The ADMIN port is a 10/100 Ethernet interface with RJ45 jack for connecting the MAIN BOARD to a laptop or PC to gain access to the local administrative interface for debug and manual configuration utilities.
 - b) The port uses auto-sensing technology to determine polarity, which permits either a straight or crossover cable to be used between the board and the computer.

Connect the LAN to the MAIN BOARD (if required)

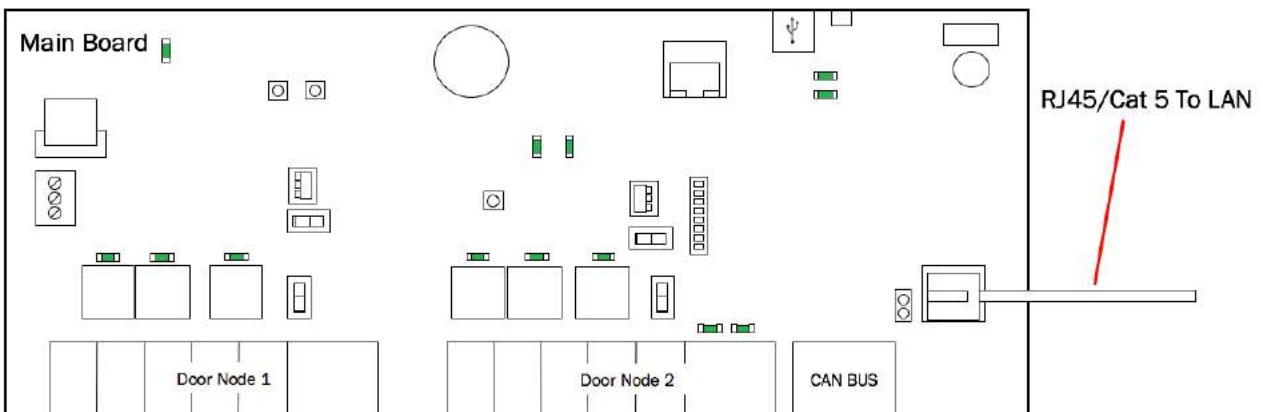

Figure 28 - Connect LAN to MAIN BOARD

1. Connect the LAN to the MAIN BOARD according to the instructions in the [Panel Networking Admin Interface Guide](#).
 - a) The LAN port is a 10/100/1000 Ethernet interface with an RJ45 jack for connecting the MAIN BOARD to a Local Area Network in order for it to gain connectivity to the Internet and the appropriate server depending upon the version of MAIN BOARD.

- b) Use a straight, (i.e., non-crossover) cable to connect this port to a local hub, switch or router that has connectivity to the Internet.
- c) The following Ethernet LED behavior represents the network speed for the LAN port on the ACS6000 control panel:
- Green LED only – 1000 M
 - Orange LED only – 100 M
 - Green LED + Orange LED – 10 M

Revision Table	Date	Author	Change
1.0	8/26/2016	LMW	Original
1.1	10/7/2016	LMW	FCC language updated
1.2	10/17/2016	LMW	Wi-Fi Antenna instructions added
1.3	4/12/2017	LMW	Updates to language and graphics after engineering review
1.4	4/26/2017	LMW	Removed reference to ACS6000-F and Brivo Onair for Government
1.5	5/17/2017	LMW	Removed reference to ACS6000-S and Brivo Onsite
1.6	11/7/2017	LMW	Replaced references to Reader/Keypad Wiring Guide with Approved Wiegand and OSDP Reader List, and added SW 7-7 functionality description
1.7	11/22/2017	LMW	Added LAN port behavior information denoting network speed
1.8	10/29/2018	LMW	Added information about the pre-assembled CAN Bus connection cable